



padilla
nicás

**SEWAGE
TREATMENT
PLANT OF
SAN
CLAUDIO**



LOCATION AND SURROUNDINGS

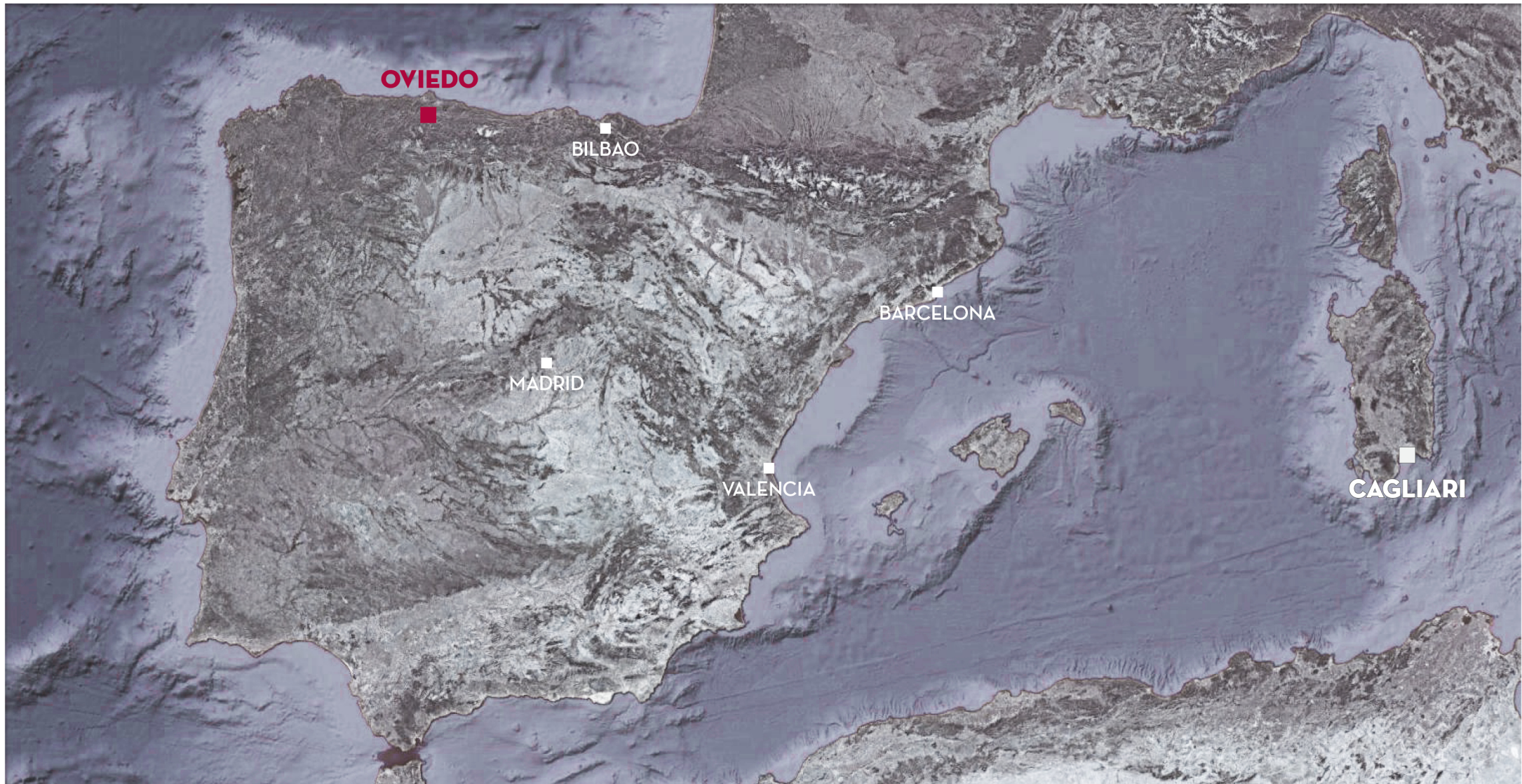

© Google

LOCATION AND SURROUNDINGS



© Google

LOCATION AND SURROUNDINGS

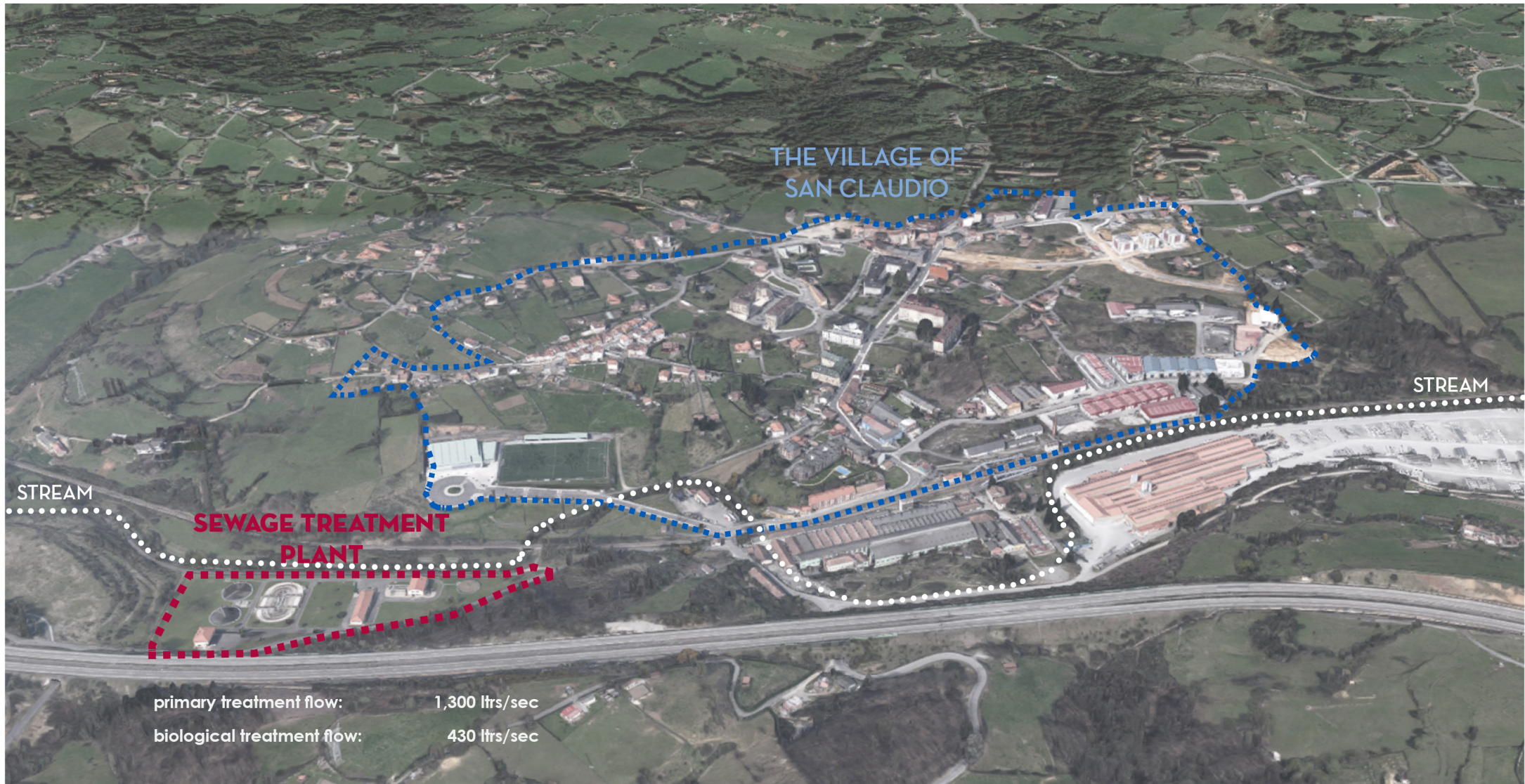

© Google

STARTING FACTORS

BUILDINGS' LOCATION

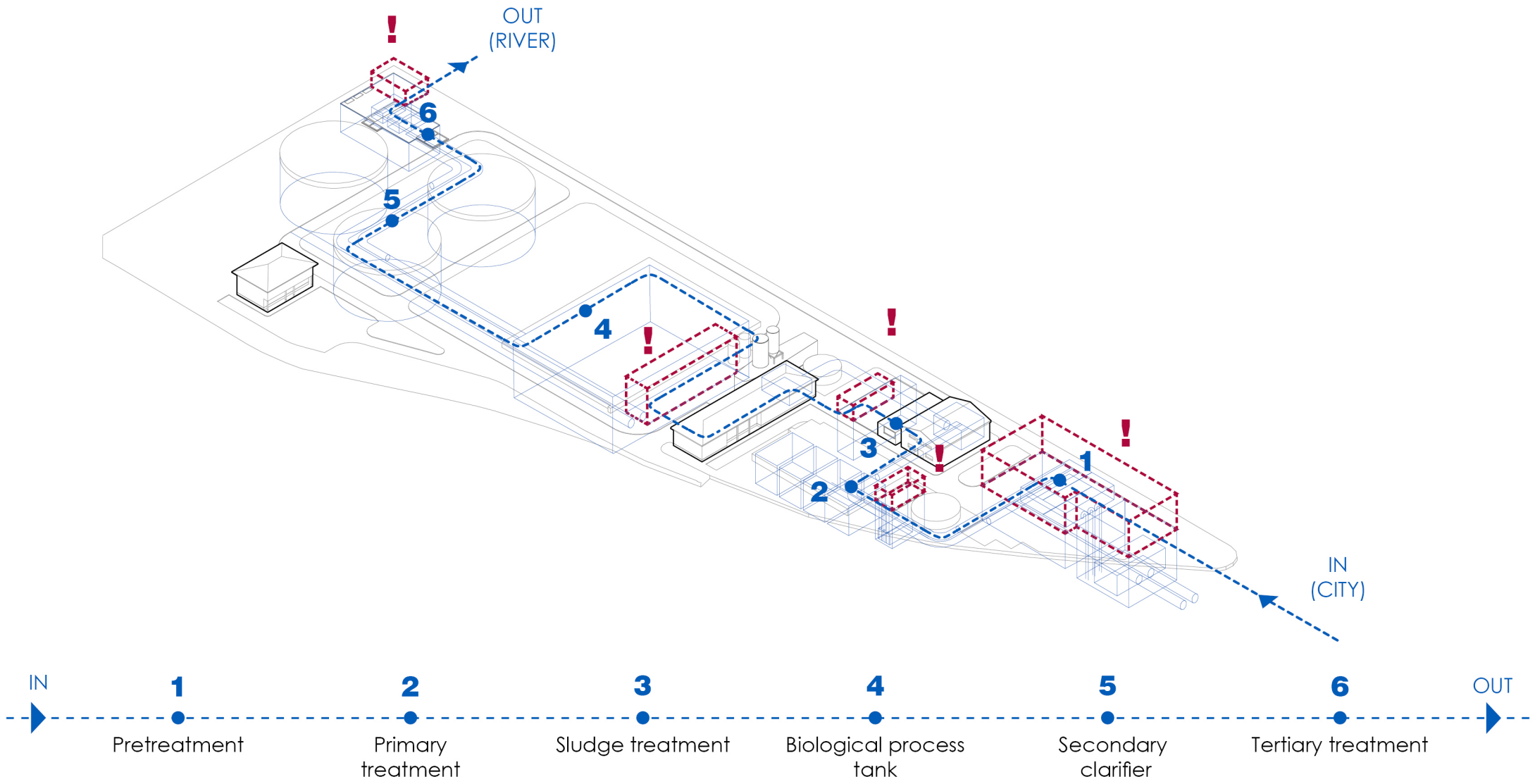

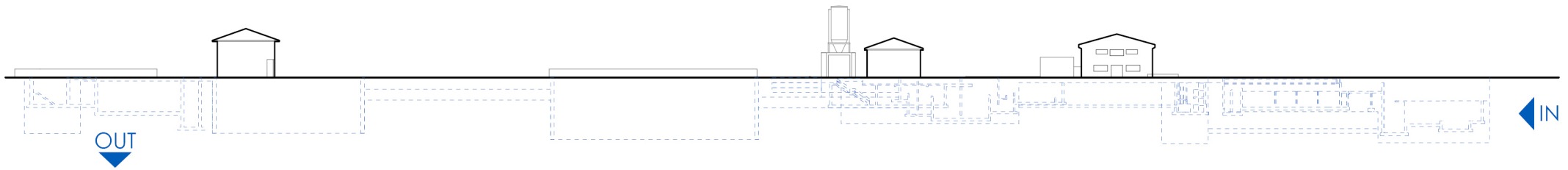

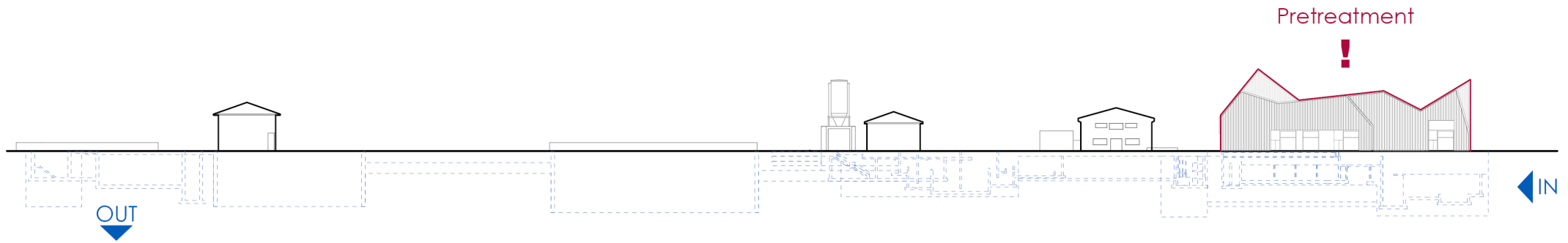

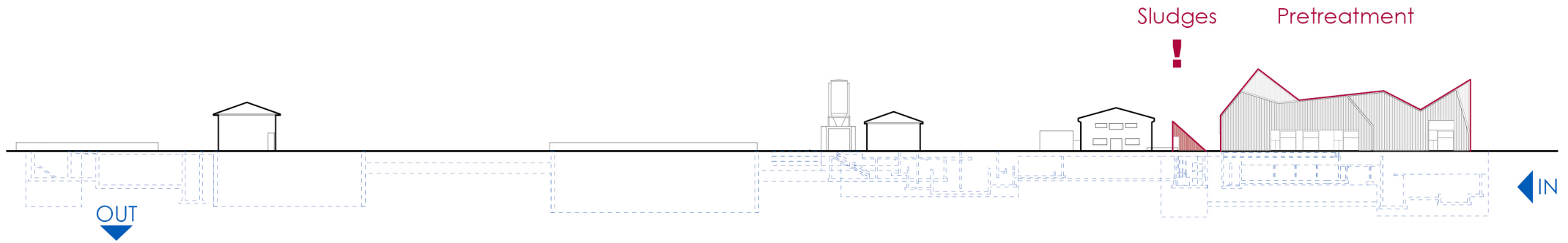

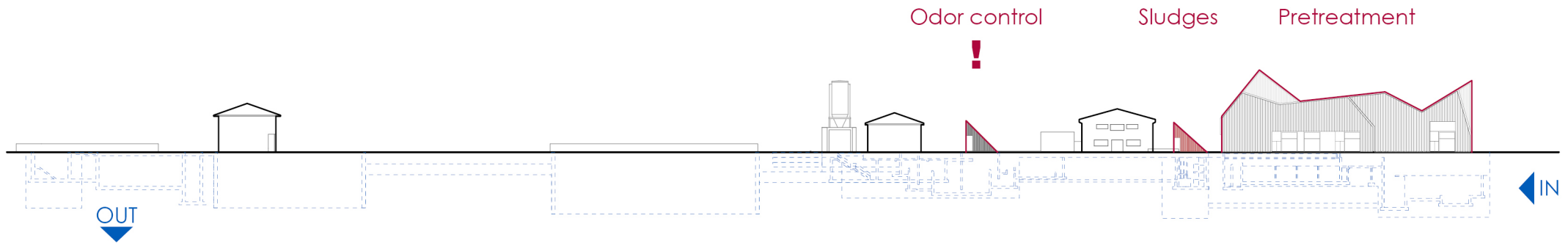

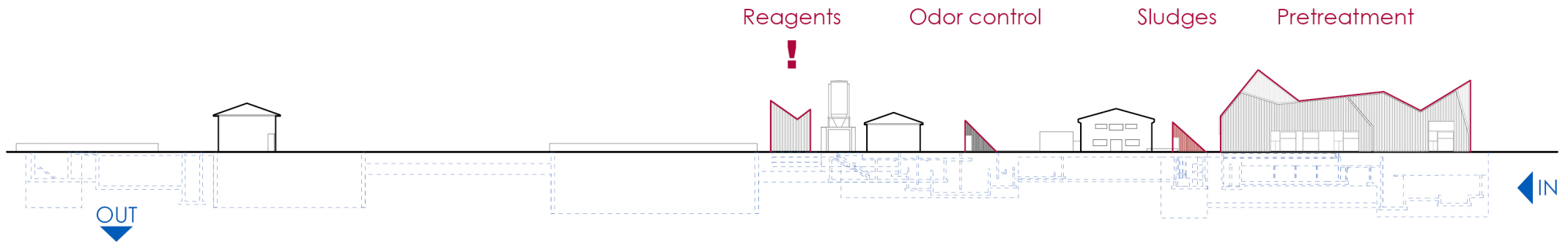

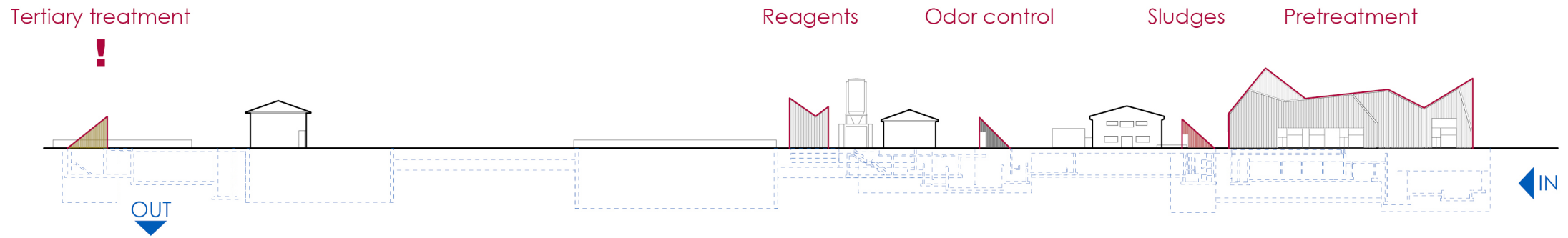

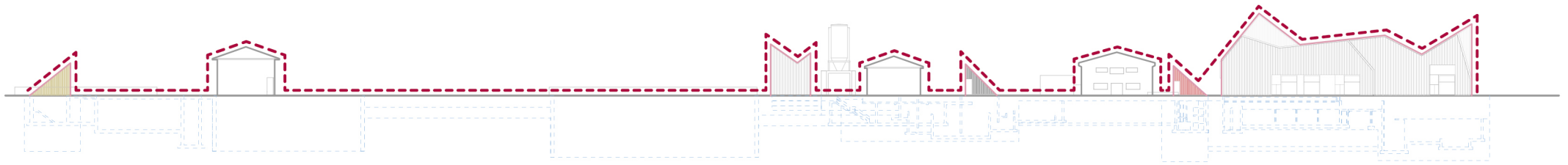



© Google



© Google

THE FINAL RESULT



Mariela Apollonio

THE FINAL RESULT

NEW ORGANIZATION

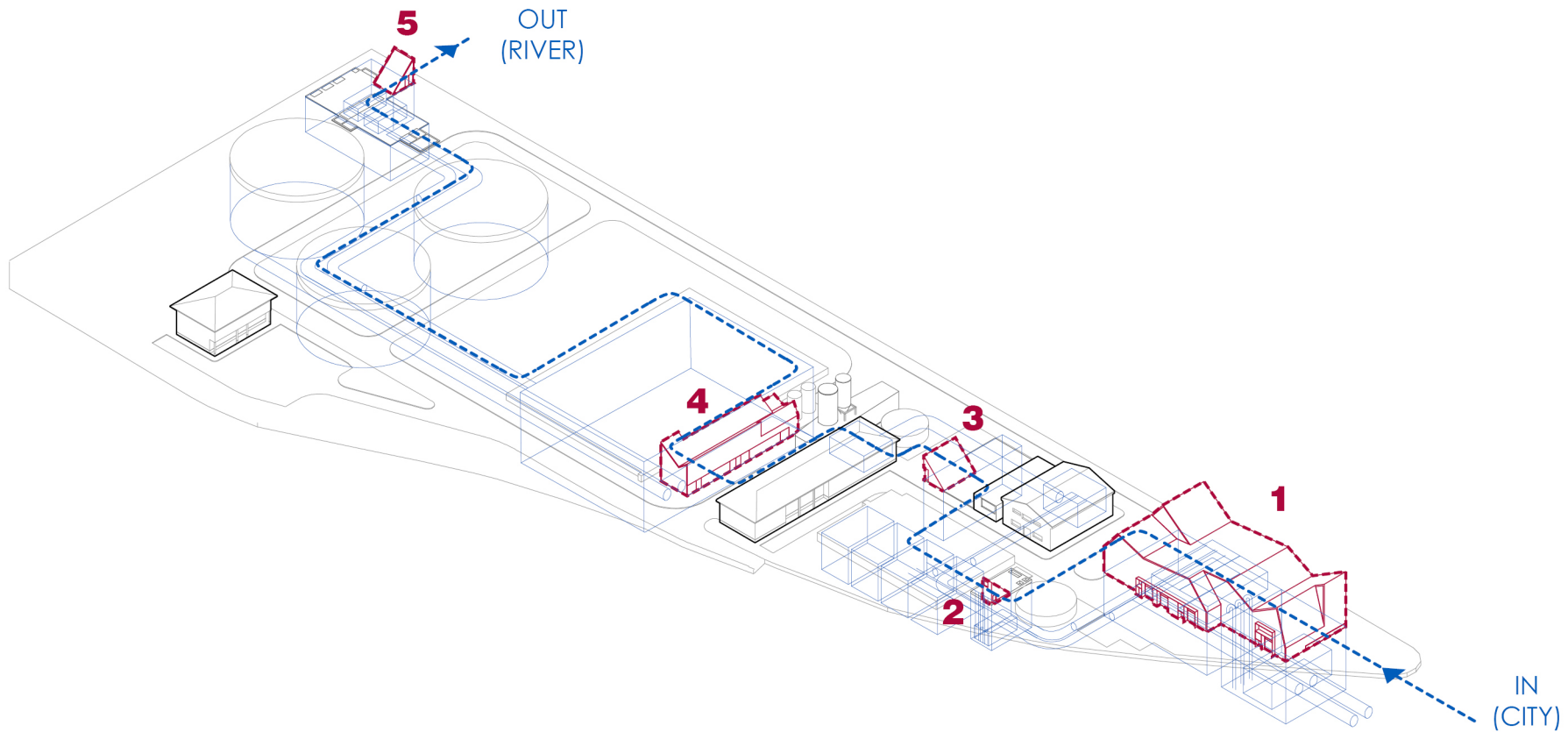

1
■
Pretreatment

2
■
Sludges

3
■
Odor control

4
■
Reagents

5
■
Tertiary treatment

THE ENCLOSURE

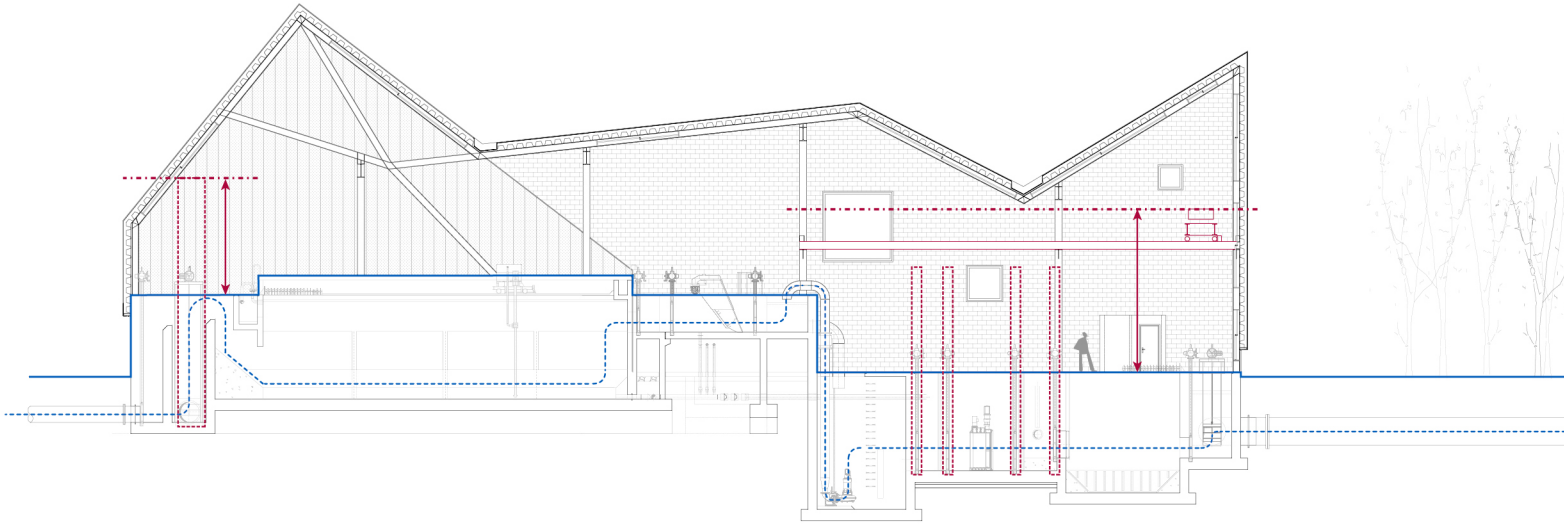

PRETREATMENT

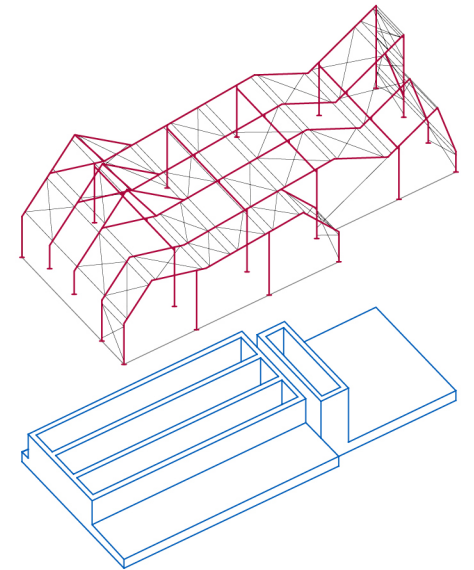
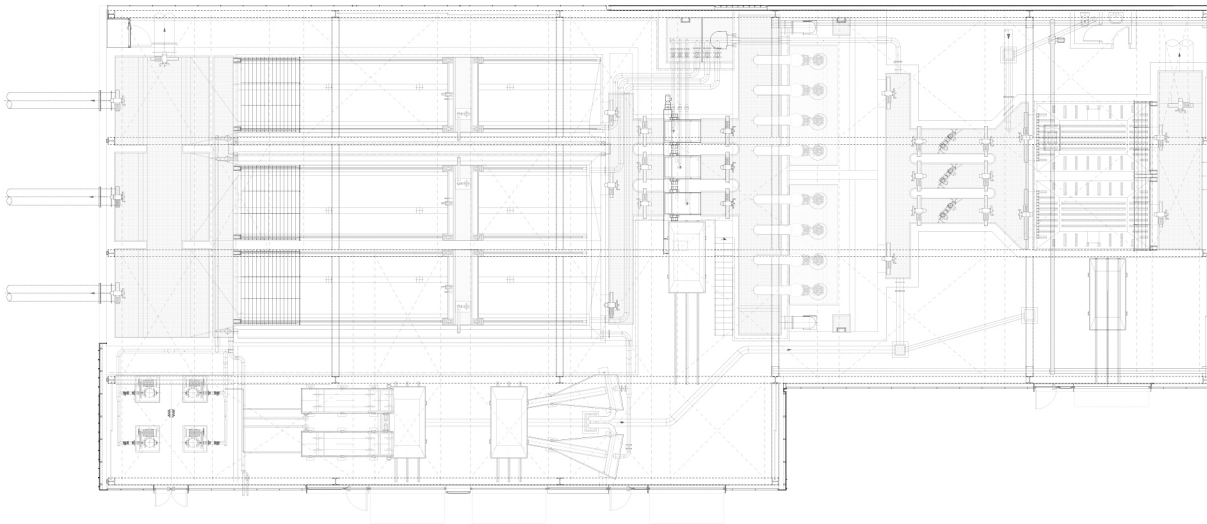
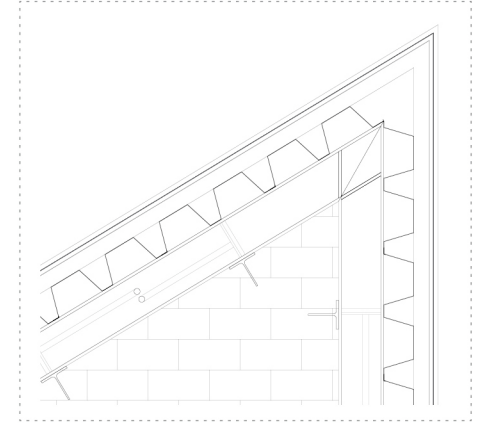

THE ENCLOSURE

REAGENTS

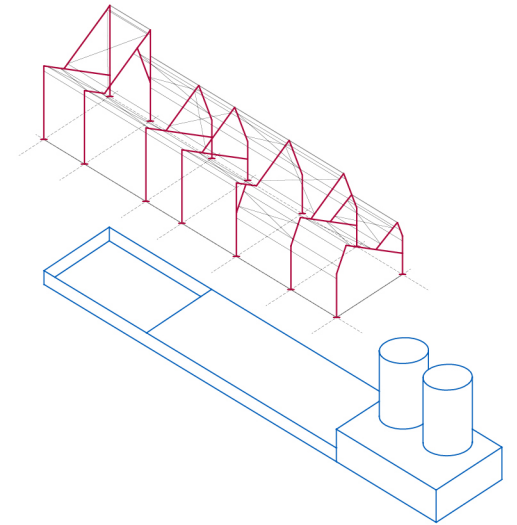
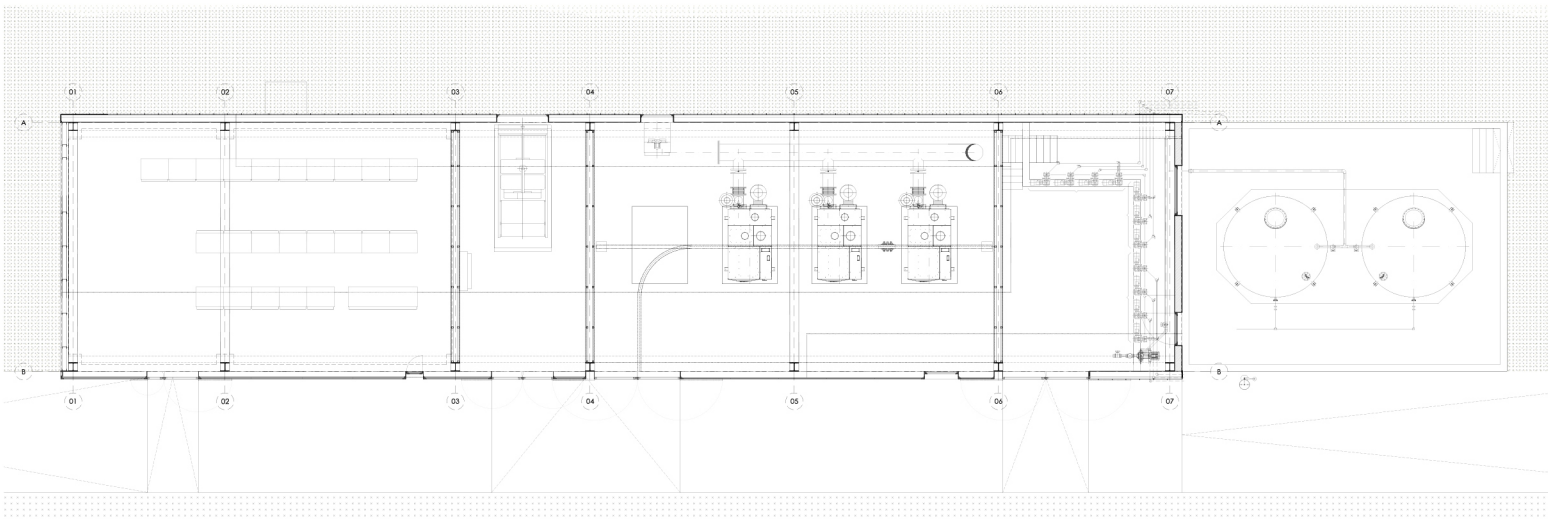
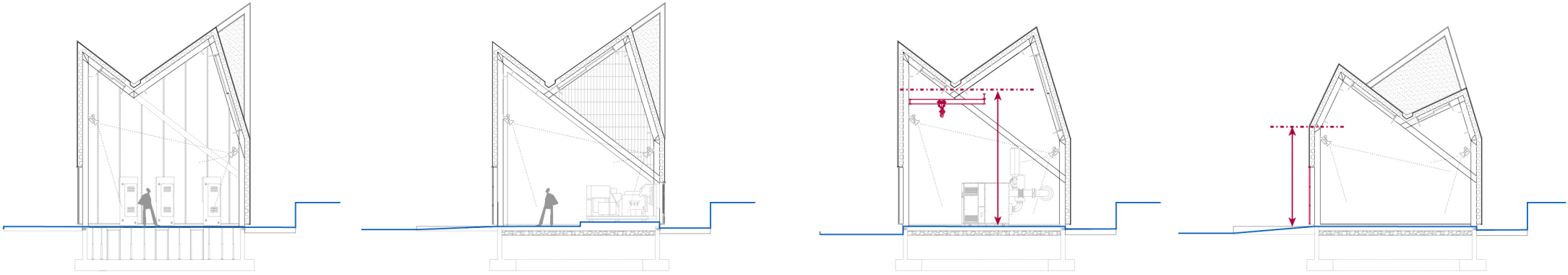

THE ENCLOSURE

MANHOLES

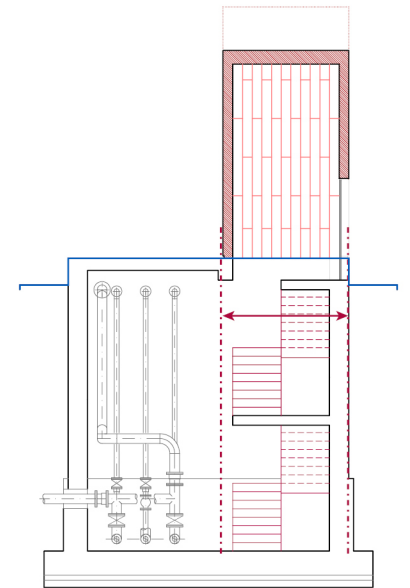
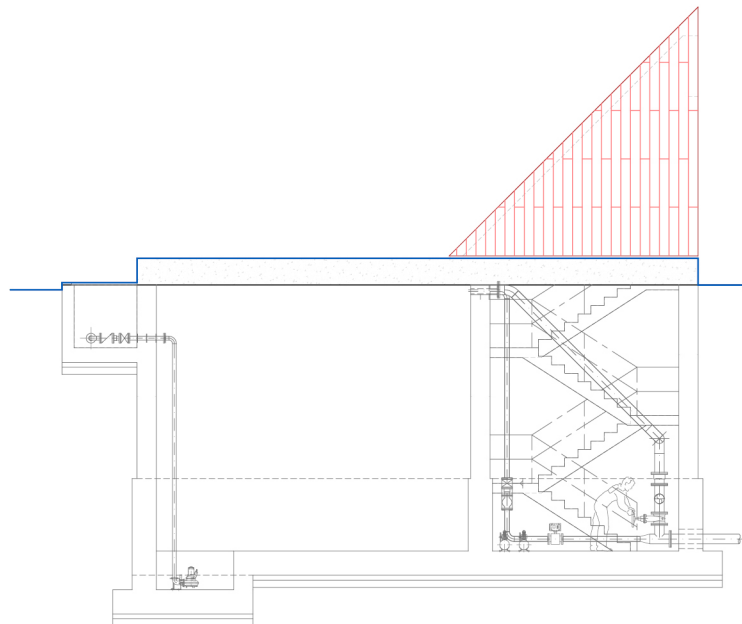
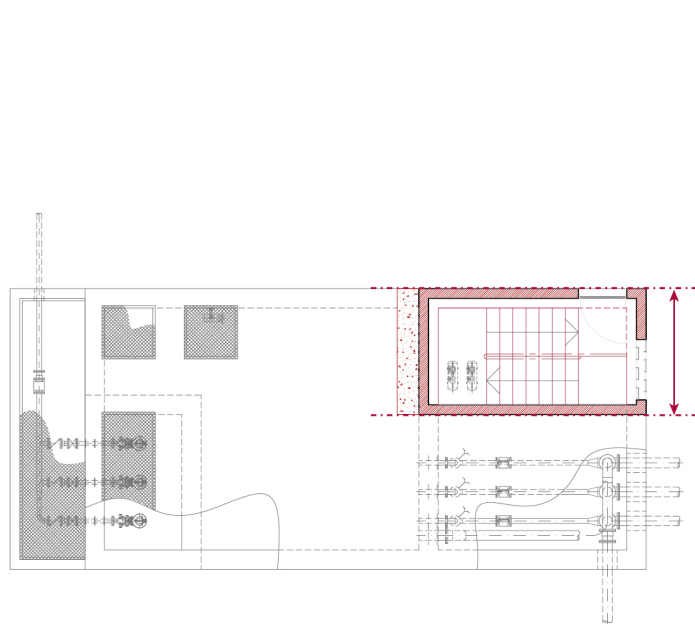
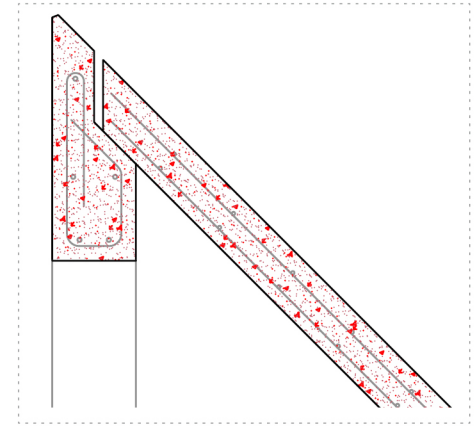
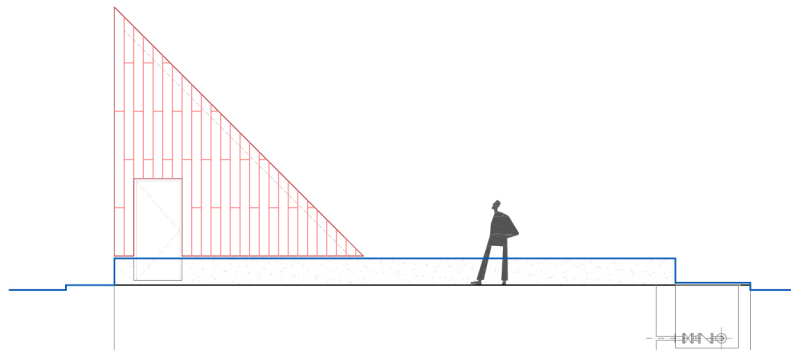
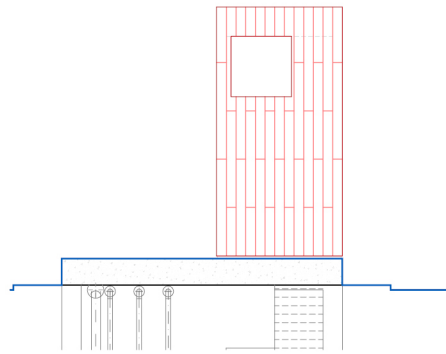

THE ENCLOSURE

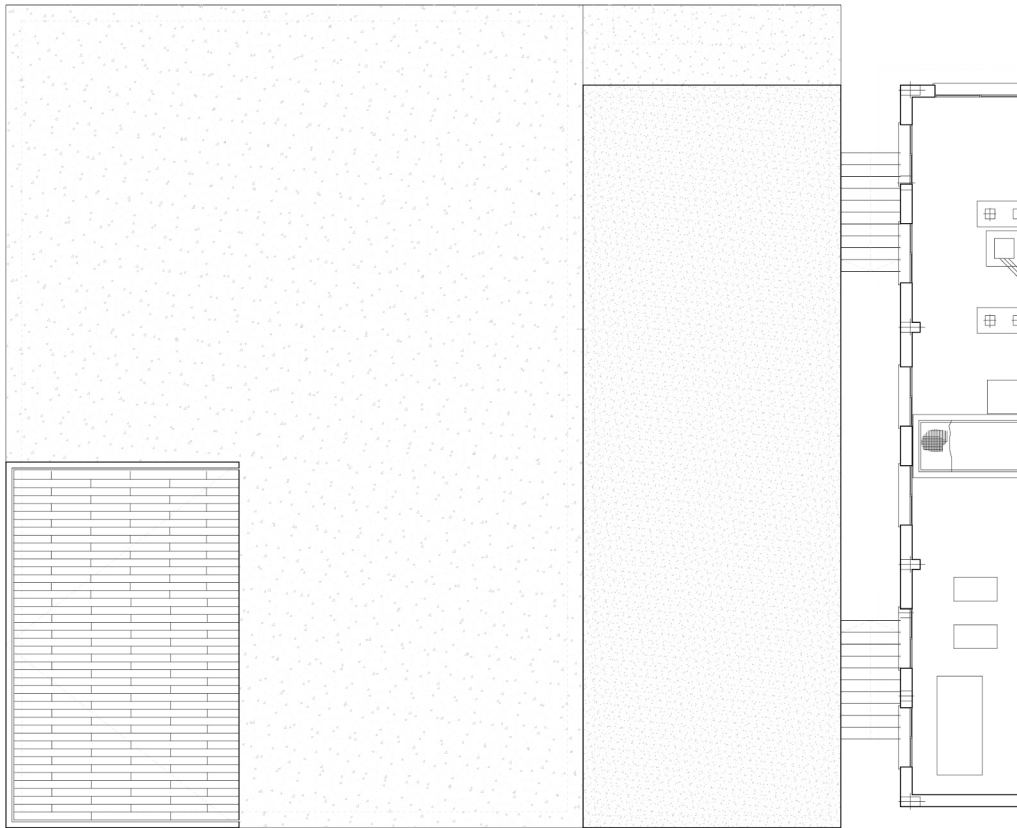

MANHOLES

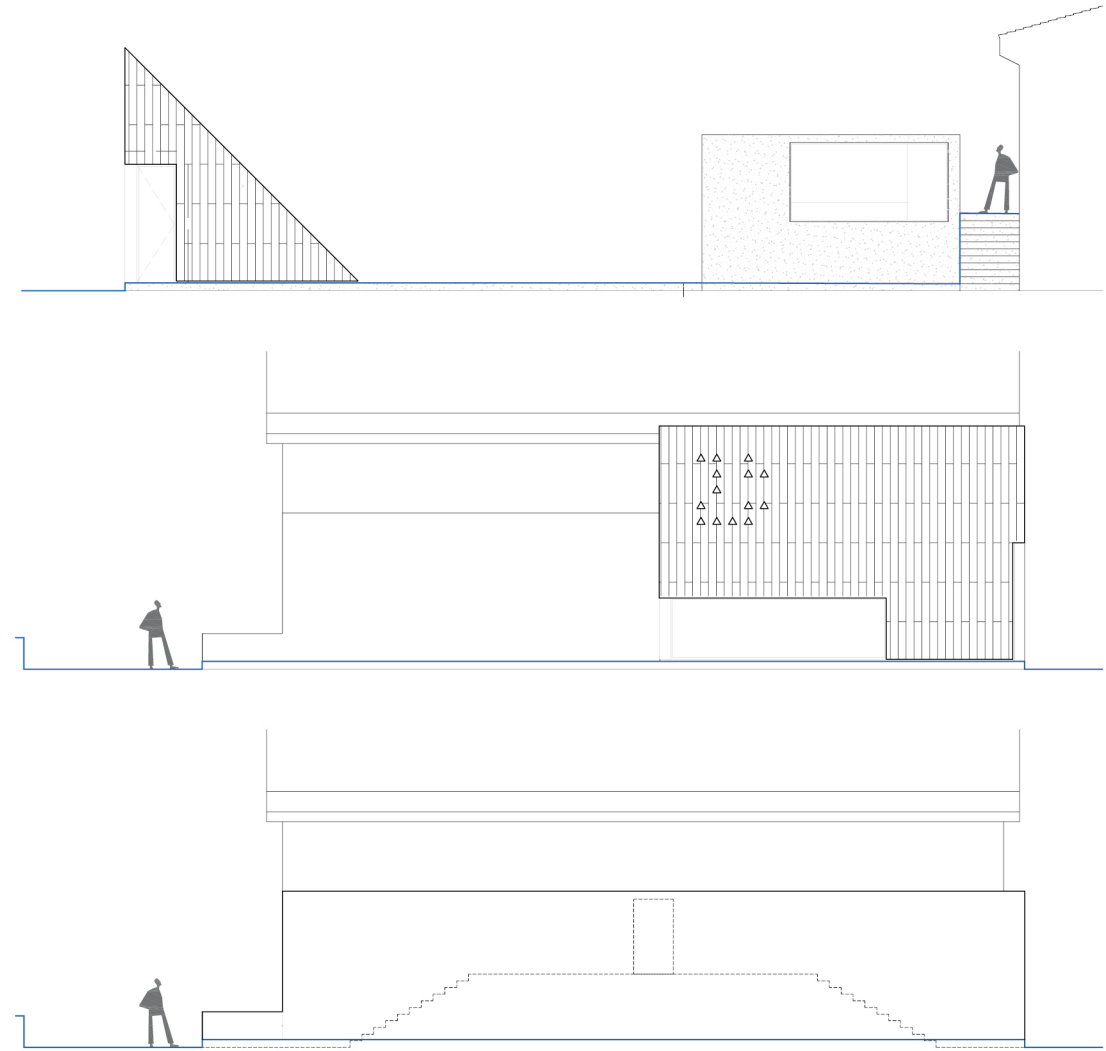

THE ENCLOSURE

MANHOLES

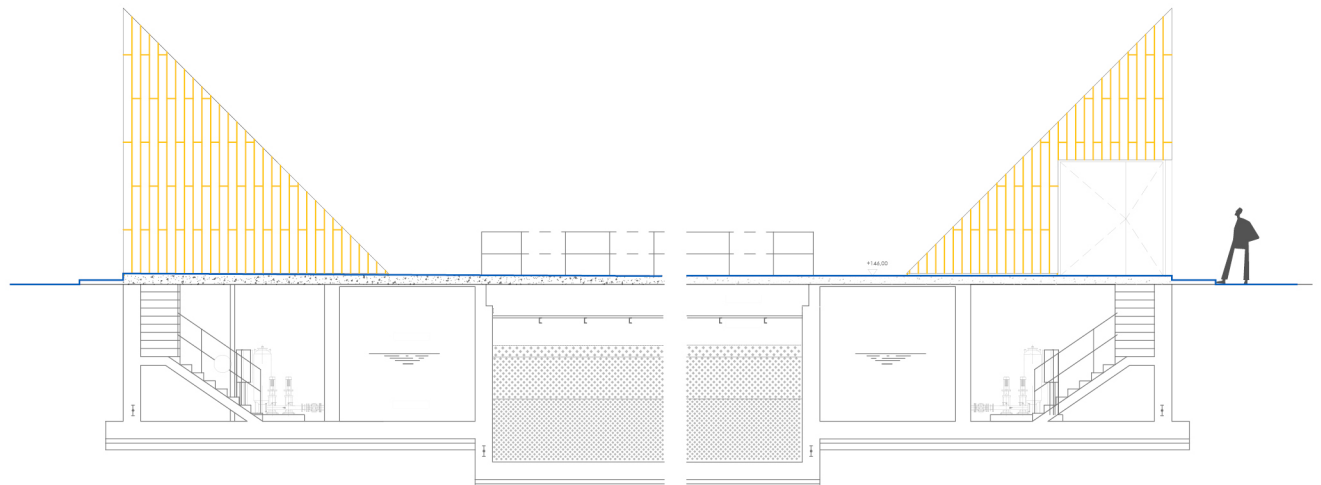
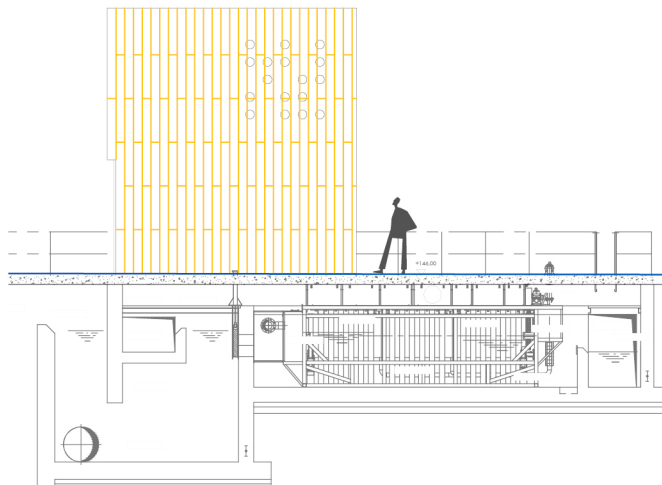
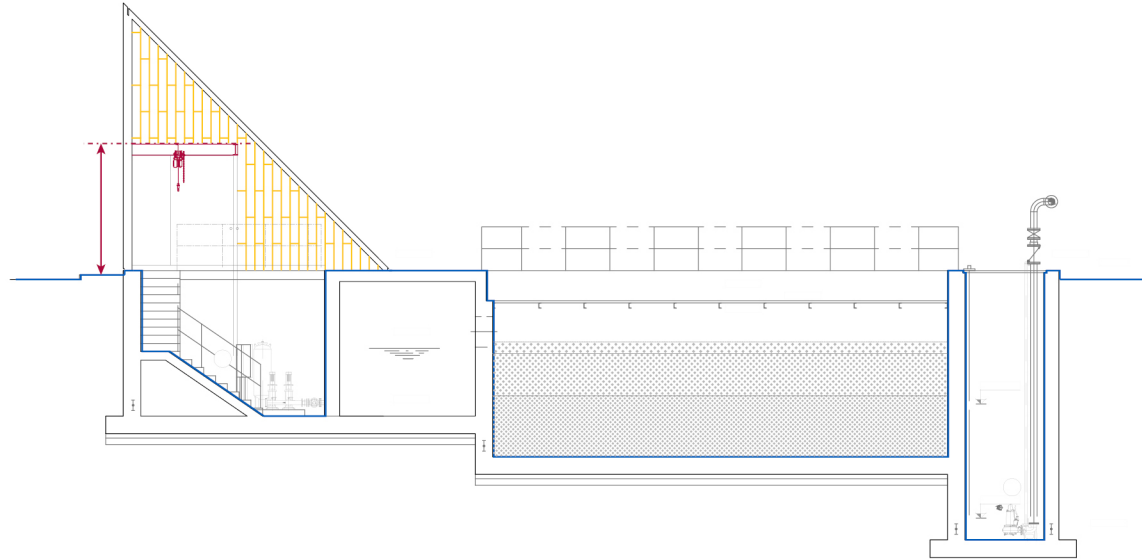
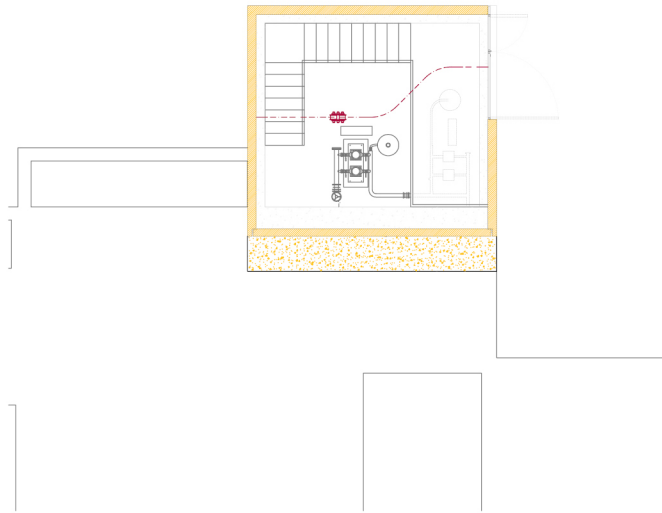

MATERIALS



Mariela Apollonio

MATERIALS



EMBOSED ALUMINIUM



**EMBOSED ALUMINIUM IS TO
DEMATERIALIZATE THE VOLUMES REDUCING
THEIR IMPACT**



LIGHTNESS

**EASY
MAINTAINANCE**

LOW COST

Mariela Apollonio

MATERIALS



Mariela Apollonio

TRANSLUCENT POLYCARBONATE

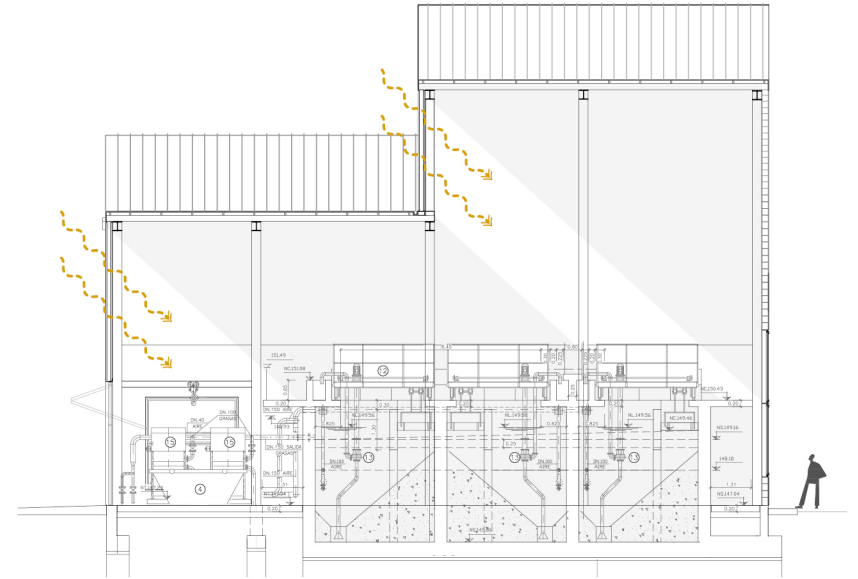

**TRANSLUCENT POLYCARBONATE ALLOWS
NATURAL LIGHTING INSIDE THE BUILDINGS**



NATURAL LIGHT

**QUICK
CONSTRUCTION**

FLEXIBILITY

MATERIALS



Mariela Apollonio

COLOURED CONCRETE

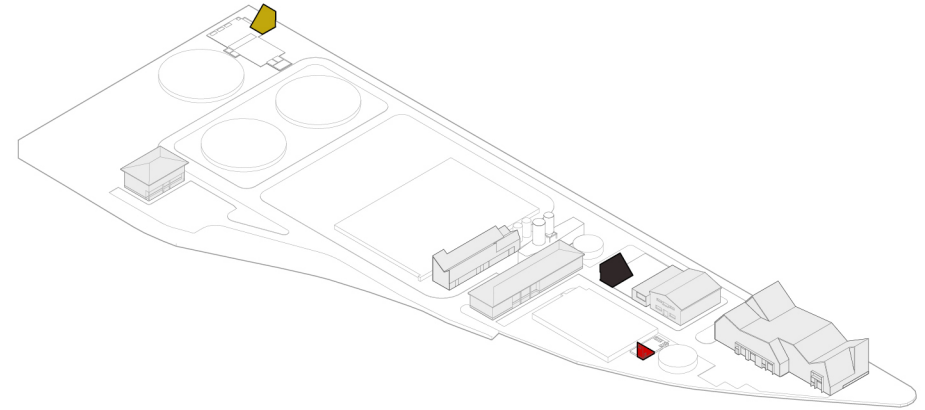

COLOURED CONCRETE HELPS THE IDENTIFICATION OF SMALL SIZED CHESTS INSIDE THE STATION



ICONIC

ORIENTATION

ROUGHNESS

SEWAGE TREATMENT PLANT OF SAN CLAUDIO



SEWAGE TREATMENT PLANT OF SAN CLAUDIO



SEWAGE TREATMENT PLANT OF SAN CLAUDIO



SEWAGE TREATMENT PLANT OF SAN CLAUDIO



SEWAGE TREATMENT PLANT OF SAN CLAUDIO

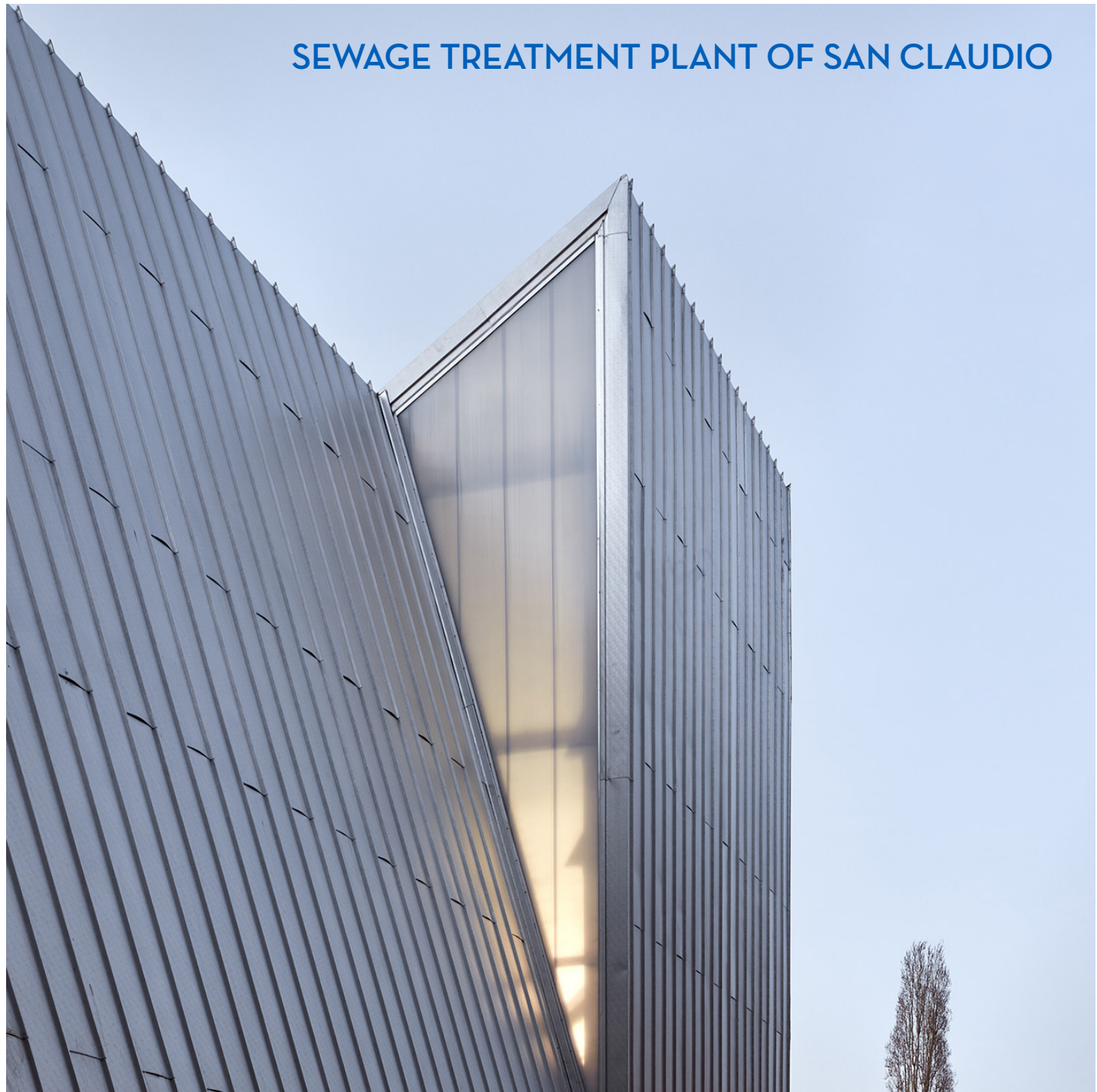

SEWAGE TREATMENT PLANT OF SAN CLAUDIO



SEWAGE TREATMENT PLANT OF SAN CLAUDIO



SEWAGE TREATMENT PLANT OF SAN CLAUDIO



Mariela Apollonio

SEWAGE TREATMENT PLANT OF SAN CLAUDIO



SEWAGE TREATMENT PLANT OF SAN CLAUDIO



SEWAGE TREATMENT PLANT OF SAN CLAUDIO



Mariela Apollonio

SEWAGE TREATMENT PLANT OF SAN CLAUDIO



SEWAGE TREATMENT PLANT OF SAN CLAUDIO



SEWAGE TREATMENT PLANT OF SAN CLAUDIO

ACUAS
AGUAS DE LAS CUENCAS DE ESPAÑA SA

padilla
nicás

CREDITS

DEVELOPER

ACUAES

ACUAES MANAGEMENT

CÉSAR PRIETO
VANESA MATEO

ARCHITECTURE

PADILLA NICÁS ARQUITECTOS

FRANCISCO PADILLA
JUAN MANUEL NICÁS

STRUCTURE

BERNABEU INGENIEROS

COLLABORATORS

ALFONSO LÓPEZ
DANIEL GUERRA
ALBA ROMERO
GIUSY DI PINTO

CONSTRUCTION BUDGET

ALVARO RIVERA

CONSTRUCTOR

FCC AQUALIA (TBA)

PHOTOGRAPHY

MARIELA APOLLONIO

SLIDE SHOW

ALICIA PEÑA